

VECO®
JAPAN



Bolt

VECO ORIGINAL HARDWARE

BOLT

Finish Index



ANTIQUE BRASS
AB



HAIR LINE NICKEL
HLNI



ANTIQUE COPPER
AC



POLISH BRASS
PB



STAINLESS STEEL
HAIR LINE
SSHL

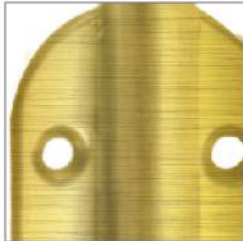

BRASS HAIR LINE
B-HL

BOLT

Solid Brass Bolt / กอลทองเหลือง

7102



Finish / สี :
AB, AC, HLNI, PB

Dimension

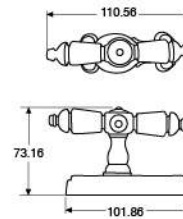

Description รุ่น	Size (A) ขนาด (A)	Material วัสดุ
7102	Made to order สั่งความยาวได้	Brass ทองเหลือง

Solid Brass Bolt / กอลทองเหลือง

7118



Finish / สี :
AB, AC, HLNI, PB

Dimension

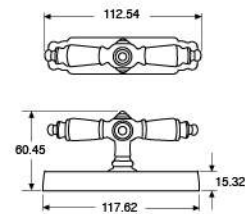

Description รุ่น	Size (A) ขนาด (A)	Material วัสดุ
7118	Made to order สั่งความยาวได้	Brass ทองเหลือง

Solid Brass Bolt / กอลทองเหลือง

CIFIAL 2523



Finish / สี :
AB, AC, HLNI, PB, B-HL

Dimension

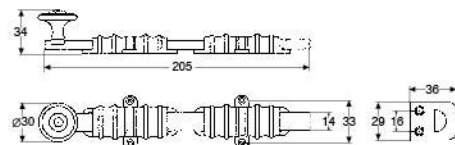

Description รุ่น	Size ขนาด	Material วัสดุ
CIFIAL 2523	8" 12" 18" 24" 48"*	Brass ทองเหลือง

* longer size available / สั่งความยาวได้

BOLT

Solid Brass Bolt / กลอนทองเหลือง

MS 660

Finish / ำ :
AB, AC, HLNI, PB

AB, AC, HLNI, PB



Dimension

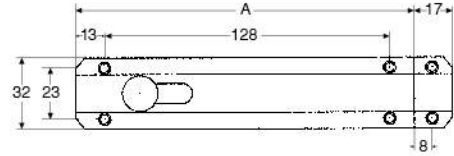

Description รุ่น	Size (A) ขนาด (A)	Material วัสดุ
MS 660	3" 4" 6" 8" 10" 12" 18" 20" 24"*	Brass ทองเหลือง

* longer size available / สั้ความยาวได้

Solid Brass Bolt / กลอนทองเหลือง

No. 440

Finish / ำ :
AB, AC, HLNI, PB

AB, AC, HLNI, PB



Dimension

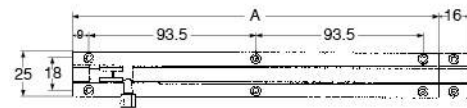

Description รุ่น	Size (A) ขนาด (A)	Material วัสดุ
NO. 440	2" 4" 6" 8" 10" 12"*	Brass Grade A ทองเหลืองเกรด A

* longer size available / สั้ความยาวได้

Solid Brass Bolt / กลอนทองเหลือง

No. 441

Finish / ำ :
AB, AC, HLNI, PB

AB, AC, HLNI, PB



Dimension

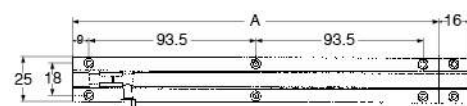

Description รุ่น	Size (A) ขนาด (A)	Material วัสดุ
NO. 441	4" 6"	Brass ทองเหลือง

* longer size available / สั้ความยาวได้

BOLT

Solid Brass Bolt / กลอนทองเหลือง

No. 450

Finish / ี :
AB, AC, HLNI, PB

AB, AC, HLNI, PB



Dimension

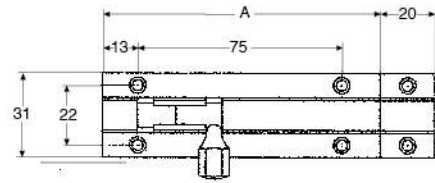

Description รุ่น	Size (A) ขนาด (A)	Material วัสดุ
NO. 450	2" 4" 6" 8" 10" 12"*	Brass Grade A ทองเหลืองเกรด A

* longer size available / สั่งความยาวได้

Solid Brass Bolt / กลอนทองเหลือง

WL 3

Finish / ี :
AB, AC, SSSL, PB

AB, AC, SSSL, PB



Dimension

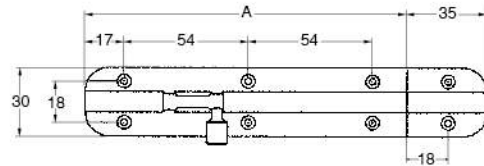

Description รุ่น	Size (A) ขนาด (A)	Material วัสดุ
WL 3	2" 4" 6" 10"	Stainless Steel SUS 304 สแตนเลสเกรด 304

Stainless Steel Bolt (With Spring) / กลอนสปริงสแตนเลส

WL 4

Finish / ี :
AB, AC, SSSL, PB

AB, AC, SSSL, PB

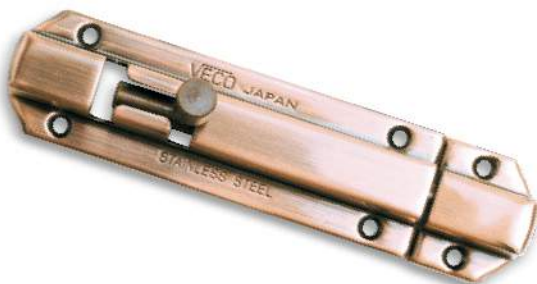

Dimension

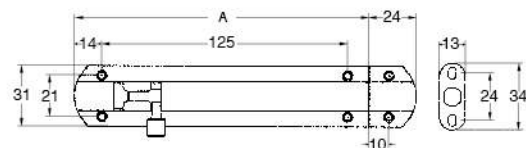

Description รุ่น	Size (A) ขนาด (A)	Material วัสดุ
WL 4	4" 6" 10"	Stainless Steel SUS 304 สแตนเลสเกรด 304

BOLT

Stainless Steel Bolt / กลอนสแตนเลส

WL 7

Finish / สี :

AB, AC, SSSL, PB



Dimension

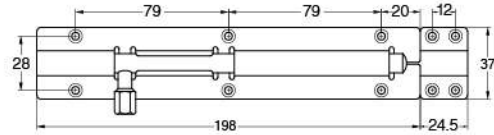

Description รุ่น	Size (A) ขนาด (A)	Material วัสดุ
WL 7	4" 6" 8"	Stainless Steel สแตนเลส

Zinc Alloy Bolt / กลอนซิงค์

No. 450Z

Finish / สี :

AB, AC, HLNI, PB



Dimension

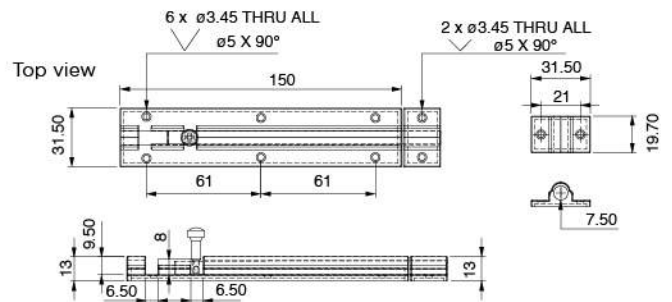

Description รุ่น	Size (A) ขนาด (A)	Material วัสดุ
No.450Z	4", 6"	Zinc Alloy No.3 ซิงค์อัลลอย เบอร์ 3

Zinc Alloy Bolt / กลอนซิงค์

WL 1

Finish / สี :

AB, AC

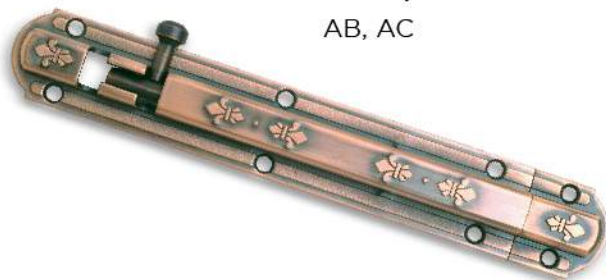

Dimension

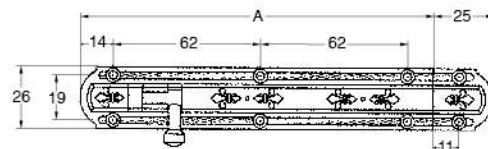

Description รุ่น	Size (A) ขนาด (A)	Material วัสดุ
WL 1	4" 6"	Zinc Alloy No.3 ซิงค์อัลลอย เบอร์ 3

BOLT

Zinc Alloy Bolt / กลอนซิงค์

WL 2

Finish / สี :
AB, AC, HLNI, PB



Dimension

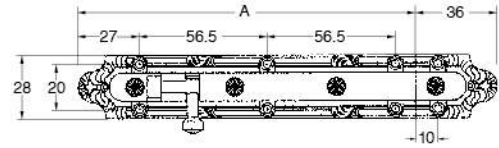

Description รุ่น	Size (A) ขนาด (A)	Material วัสดุ
WL 2	4" 6"	Zinc Alloy No.3 ซิงค์อัลลอย เบอร์ 3

Zinc Alloy Bolt / กลอนซิงค์

WL 5

Finish / สี :
AB, AC, HLNI, PB



Dimension

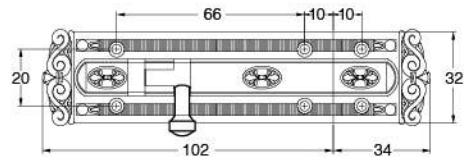

Description รุ่น	Size (A) ขนาด (A)	Material วัสดุ
WL 5	4"	Zinc Alloy No.3 ซิงค์อัลลอย เบอร์ 3

Zinc Alloy Bolt / กลอนซิงค์

WL 6

Finish / สี :
AB, AC, HLNI, PB

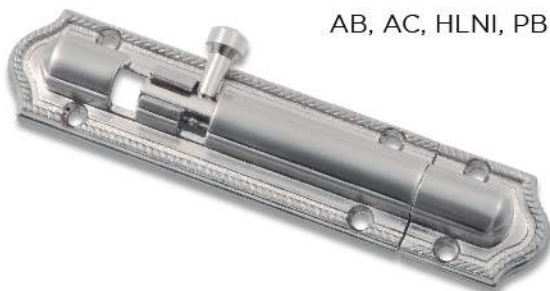

Dimension

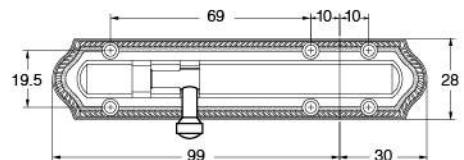

Description รุ่น	Size (A) ขนาด (A)	Material วัสดุ
WL 6	4" 6"	Zinc Alloy No.3 ซิงค์อัลลอย เบอร์ 3

BOLT

Stainless Steel Flush Bolt / กอนฝิ่งสแตนเลส

No. 111

Finish / ฝ้ :

SSHL



Description รุ่น	Size (A) ขนาด (A)	Material วัสดุ
NO. 111	6"	Stainless Steel SUS 304 สแตนเลสเกรด 304

Dimension

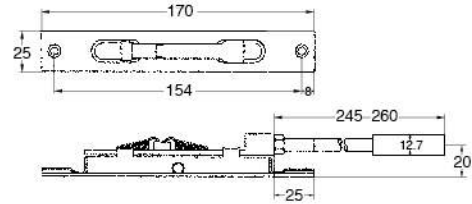

Stainless Steel Flush Bolt / กอนฝิ่งสแตนเลส

No. 160

Finish / ฝ้ :

AB, AC, SSSL, PB



Dimension

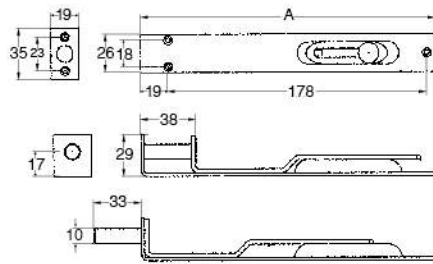

Description รุ่น	Size (A) ขนาด (A)	Material วัสดุ
NO. 160	6" 8" 12" 18" 24"*	Stainless Steel SUS 304 สแตนเลสเกรด 304

* longer size available / ส้ความยาวได้

Stainless Steel Flush Bolt / กอนฝิ่งสแตนเลส

No. 250

Finish / ฝ้ :

AB, AC, SSSL, B-HL

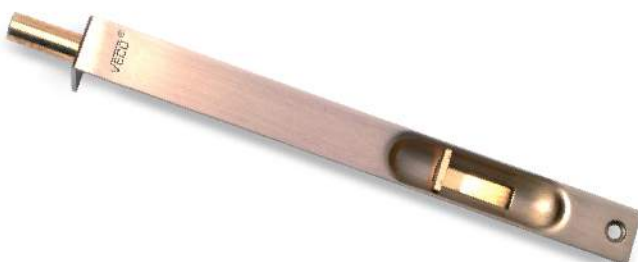

Dimension

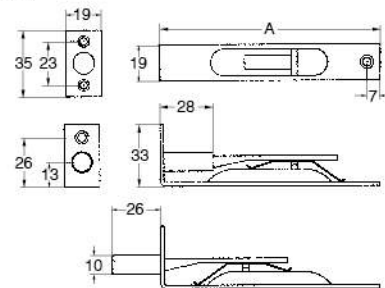

Description รุ่น	Size (A) ขนาด (A)	Material วัสดุ
NO. 250	4" 6" 8" 12"	Stainless Steel SUS 304 สแตนเลสเกรด 304

BOLT

Stainless Steel Flush Bolt / กอนฝิ่งสแตนเลส

No. 416

Finish / ฝ้ :

AB, AC, SSSL, B-HL, PB

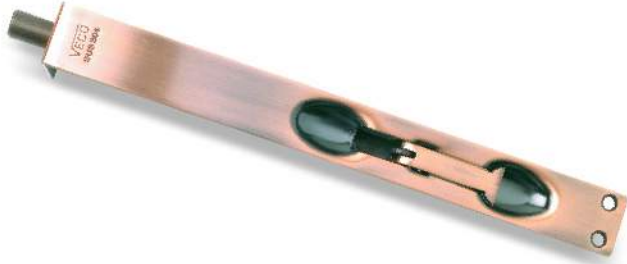

Dimension

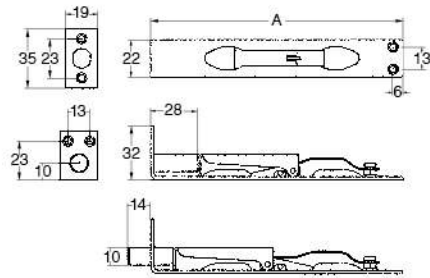

Description รุ่น	Size (A) ขนาด (A)	Material วัสดุ
NO. 416	6" 8" 12"*	Stainless Steel SUS 304 สแตนเลสเกรด 304

* longer size available / สั่งความยาวได้

Stainless Steel Flush Bolt / กอนฝิ่งสแตนเลส

No. 516

Finish / ฝ้ :

SSHL



Dimension

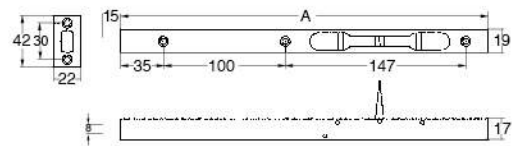

Description รุ่น	Size (A) ขนาด (A)	Material วัสดุ
NO. 516	8" 10" 12"	Stainless Steel SUS 304 สแตนเลสเกรด 304

Solid Brass Flush Bolt / กอนฝิ่งทองเหลือง

No. 240

Finish

AB, AC, HLNI, PB



Dimension

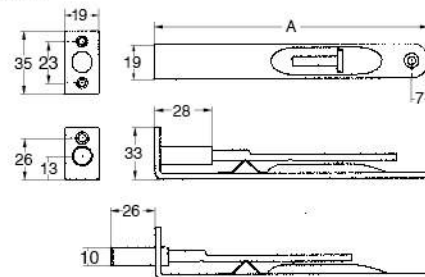

Description รุ่น	Size (A) ขนาด (A)	Material วัสดุ
NO. 240	5" 6"	Solid Brass ทองเหลือง

BOLT

Stainless Steel Toilet Bolt / กลอนห้องน้ำสแตนเลส

DL25

Finish / สี :
SSHL



Dimension

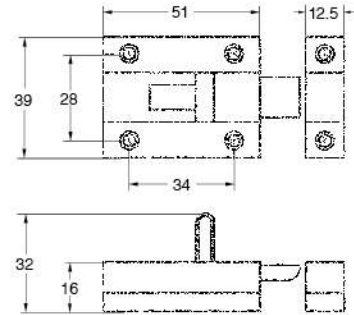

Description รุ่น	Size ขนาด	Material วัสดุ
DL25	2.5"	Stainless Steel SUS 304 สแตนเลส 304

Stainless Steel Toilet Bolt / กลอนห้องน้ำสแตนเลส

DL35

Finish / สี :
SSHL



Dimension

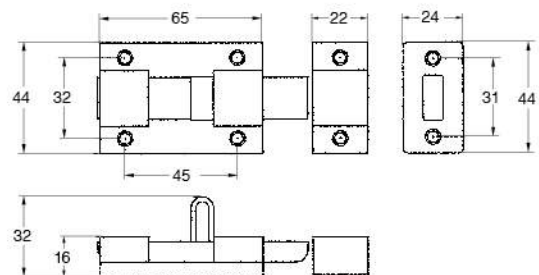

Description รุ่น	Size ขนาด	Material วัสดุ
DL35	3.5"	Stainless Steel SUS 304 สแตนเลส 304

BOLT

Stainless Steel Toilet Bolt / กลอนห้องน้ำสแตนเลส

DL70

Finish / สี :
SSHL

Dimension

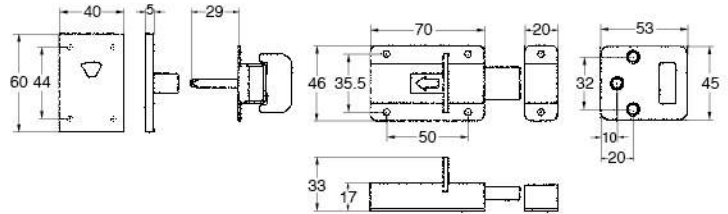

Description รุ่น	Material วัสดุ
DL70	Stainless Steel SUS 304 with Indicator สแตนเลสเกรด 304 พร้อมป้าย
	Stainless Steel SUS 304 without Indicator สแตนเลสเกรด 304 ไม่พร้อมป้าย

Stainless Steel Toilet Bolt / กลอนห้องน้ำสแตนเลส

DL 112



Dimension

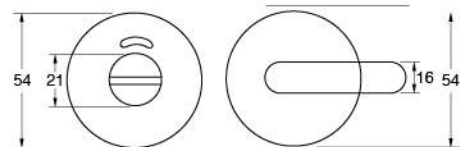

Description รุ่น	Material วัสดุ
DL 112	Stainless Steel SUS 304 สแตนเลสเกรด 304

BOLT

Stainless Steel Toilet Bolt / กลอนห้องน้ำสแตนเลส

DL 120



ด้านนอกห้อง



ด้านในห้อง

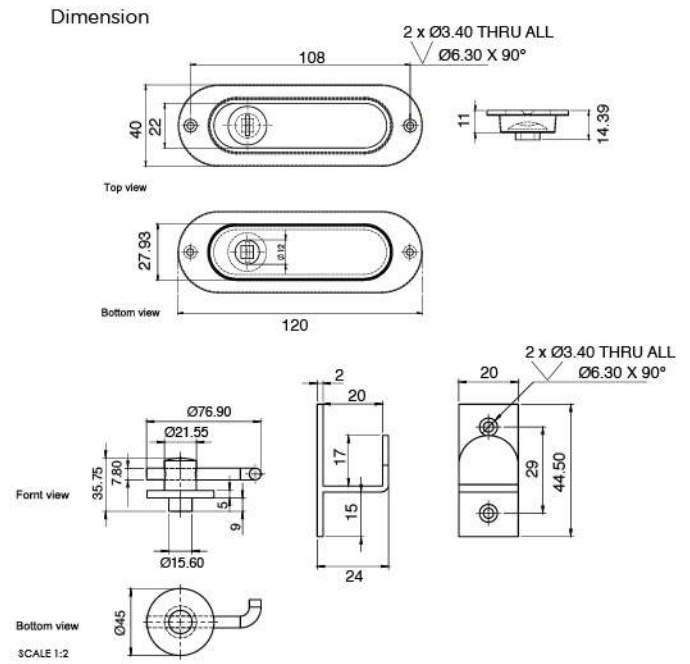

Description รุ่น	Material วัสดุ
DL 120	Stainless Steel SUS 304 สแตนเลสเกรด 304

Door Chain / กลอนโซ่

CS900

Finish / สี :

AB, AC, HLNI, PB



Dimension

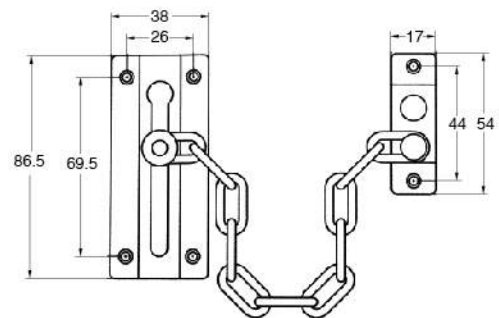

Description รุ่น	Material วัสดุ
CS900	Steel เหล็ก

BOLT

Door Chain / กอญโซ่

CS1000

Finish / ี :

AB, AC, SSSL, PB



Dimension

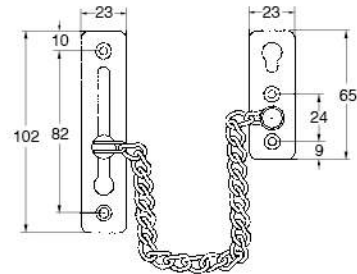

Description ຮຸ່ນ	Material ໄວ້ຈຸ
CS1000-SB	Stainless Steel SUS 304 with Steel chain ສາຕັນເສດຖະ 304 ໄຊເລັກ
CS1000-STEEL	Steel ຕັ້ວເລັກ ໄຊເລັກ
CS1000	Stainless Steel SUS 304 with Stainless Steel Chain ສາຕັນເສດຖະ 304 ໄຊສາຕັນເສດ

Door Bolt for Padlock / ກອນຫວາງ

CS2000

Finish / ື :

AC, SSSL



Dimension

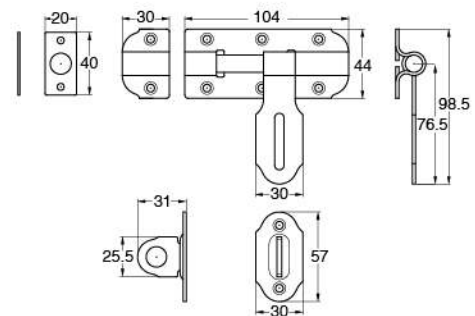

Description ຮຸ່ນ	Material ໄວ້ຈຸ
CS2000	Stainless ສາຕັນເສດ

BOLT

Door Bolt for Padlock / កាតស៊ុយ

H 001



Dimension

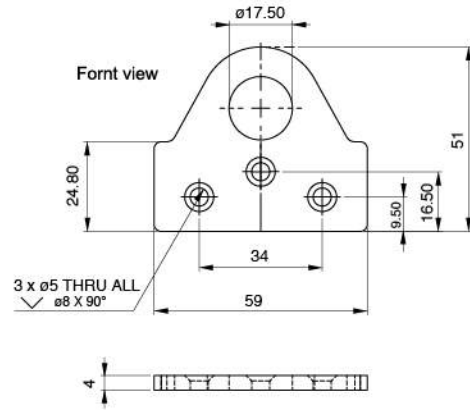

Description ឧបករណ៍	Material ឧបករណ៍
H 001	Steel ដែក